



ALPHASONIK®

TSW310/TSW312

TREIS 300 SERIES

SETTING THE PACE SINCE 1976

ALPHASONIK WAS FOUNDED IN 1976 WITH ONE MISSION, TO BRING STATE OF THE ART PERFORMANCE TO THE CAR AUDIO ENTHUSIAST.

In these early years we pioneered such ground-breaking technologies as amplifier fan cooling and high voltage signal transfer which remain a benchmark in high-end audio.

Today, the new Alphasonik is committed to pushing the envelope with regards to technology, quality and value. Our electronics feature audiophile parts and circuit topology designed to let the full musical experience come through, loud and clear. Our loudspeakers employ the latest high technology materials and processes such as carbon reinforced woven glass and titanium vapor deposition to deliver your music with tremendous impact, dynamics and resolution.

We stand behind our quality with one of the best warranties in consumer electronics. Compare Alphasonik car audio products against anything the competition has to offer. We're confident you will come to one conclusion...

ALPHASONIK HAS NO EQUAL.



WARNING: This product can expose you to chemicals including DEHP which is known to the State of California to cause Cancer, Birth Defects or other reproduction harm. For more information go to www.P65warnings.ca.gov.



INTRODUCTION.....	2
FEATURES AND SPECIFICATIONS.....	3
BUILDING AN ENCLOSURE.....	4 - 8
SUBWOOFER PARAMETERS.....	9
WIRING DIAGRAM.....	10
TROUBLESHOOTING.....	11
WARNING/DISCLAIMER.....	12
WARRANTY.....	13 - 14

Thank you for purchasing this Alphasonik product. Alphasonik products are specifically engineered and designed for the mobile audio environment. This manual contains important information about installation, set-up procedures and integrating your new Alphasonik product into your vehicle. With proper care and installation, your new product will provide you with many years of high performance listening enjoyment. We recommend having an Authorized Alphasonik Dealer install your new product for optimal performance and to take advantage of our warranty program. Before installing your new product, please read through the manual to fully understand the application.

Before making any electrical connections, make sure that you disconnect the battery's ground cable to prevent the possibility of short circuits or damage to your electronic equipment. If your vehicle's stereo (head unit) comes with an Anti-theft code, DO NOT disconnect the battery. If you have the access code for the stereo (head unit), please refer to the vehicle's owner's manual.



TSW310

10" TREIS 200 SERIES SUBWOOFER

Proprietary Low Profile Heavy Gauge Stamped Steel "Alpha" Basket

EPDM surround for Enhanced Control at Extreme Temperatures

Spun Aluminum Cone

Rated at 400 watts RMS / 1200 watts MAX

84 dB @ 1w/1m

48 oz Magnet

Frequency Response: 28 - 500 Hz

Single 4Ω 2" voice coils

8-gauge nickel plated input terminals

Mounting Dimensions - Depth: 89mm / 3.5"

[Through Hole: 244mm / 9.6"] Diameter: 264mm / 10.39"

TSW312

12" TREIS 200 SERIES SUBWOOFER

Proprietary Low Profile Heavy Gauge Stamped Steel "Alpha" Basket

EPDM surround for Enhanced Control at Extreme Temperaturest

Spun Aluminum Cone

Rated at 500 watts RMS / 1500 watts MAX

86 dB @ 1w/1m

62 oz Magnet

Frequency Response: 24 - 500 Hz

Single 4Ω 2" voice coils

8-gauge nickel plated input terminals

Mounting Dimensions - Depth: 89mm / 3.5"

[Through Hole: 292mm / 11.5"] Diameter: 321mm / 12.6"

Now that you know about subwoofer specifications it's time to learn about building subwoofer boxes. If you've done any woodworking you shouldn't have much trouble when building a subwoofer enclosure. One of the main differences will probably be the material used in building subwoofer boxes as compared to other woodworking projects. When building a custom subwoofer box you will want to use minimal MDF (medium density fiberboard).

TOOLS REQUIRED TO BUILD AN ENCLOSURE

Safety goggles

Table saw or circular saw

Powered screw gun

Router or jig saw

Variety of sizes of drill bits

Wood glue

Silicone

Wood screws

To ensure your safety while building an enclosure, please read all manuals for the power tools you will be using, as they will include valuable information on handling the tools and safety tips.

If you're planning to build your own enclosure and are confused in what type of enclosure best suits your needs this page will help you choose what enclosure best fits your needs. There are many different types of enclosures. The two most common used enclosures are sealed and vented enclosure. This page will show the advantages and disadvantages of the two enclosures.

Advantages of a sealed enclosures

- *High power handling capability
- *Great transient response
- *Tolerant of minor enclosure size variation
- *Easy to construct
- *Smooth rolloff (12dB/octave)

Disadvantages of a sealed enclosures

- *Requires a woofer with a long excursion for better low bass frequency response.
- *Can have lower sensitivity than ported enclosures.
- *When using high power and small enclosures, the woofer is not in an ideal cooling environment.
- *Lower bass as compared to a properly tuned vented enclosure above the ported tuning frequency.

Advantages of a vented enclosure

- *Increased output around vented tuning
- *Higher power handling above the port tuning frequency
- *Extended frequency response
- *Magnet is in a good cooling environment
- *Handles higher bass frequencies with less distortion

Disadvantages of a vented enclosure

- *Vented enclosure transient response is not as good as sealed boxes because of the resonant effect of the vent tuning
- *Midrange sound coming from inside the enclosure through the vent can produce unpleasant sound coloration.
- *Loss of cone movement control below vent tuning, which can result in high distortion and mechanical failure of the driver.
- *Lower power handling below the port tuning frequency.

Calculating a sealed speaker enclosure volume is a six step process.

- Step One: Measure Height
 - Step Two: Measure Width
 - Step Three: Measure Depth
 - Step Four: Subtract Thickness of Wood
 - Step Five: Multiply Height * Width * Depth =
 - Step Six: Divide the results from step four by 1728a
- EXAMPLE: $12" * 12" * 12" / 1728 = 1.0$ cu. ft.

Complete formula should look like this

Height * Width * Depth / 1728 = _____

Below are illustrated versions of steps to calculate the enclosure volume.

(ILLUSTRATED EXAMPLE ONLY)

If measured internal dimensions you will skip step four.

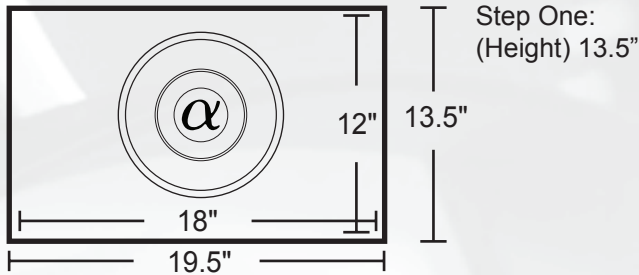

Step Two:
(Width) 18"

The wood that we are using is 0.75" thick
The 1.5" that you see in the formula is the thickness of the wood.

Step Three:
(Depth) 13.5"

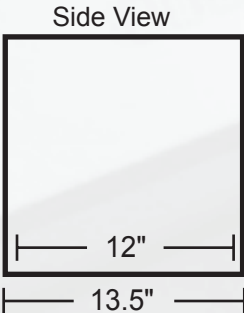

Step Four:

Calculating thickness of wood:
Measure how thick the wood is then multiply by 2.
The reason that you are multiplying by 2 is each side of the enclosure.
Width 19.5" - Left + Right(1.5") = 18"
Height 13.5" - Top + Bottom(1.5") = 12"
Depth 13.5" - Front + Back(1.5") = 12"

Step Five: $18 * 12 * 12 = 2592$

Step Six: $2592 / 1728 = 1.50$ cu. ft.

Calculating a speaker enclosure volume with a port is a seven step process. The First six steps are the same as the sealed enclosure. The only difference is calculating the port displacement.

Step One - Six: Follow the first six steps on the sealed enclosure.

(ILLUSTRATED EXAMPLE ONLY)

If measured internal dimensions you will skip step four.

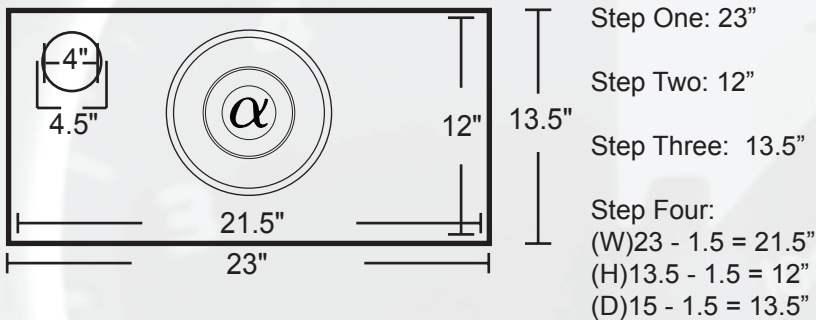

- Step Five: $21.5 * 12 * 13.5 = 3483$
 Step Six: $3483 / 1728 = 2.01$ cu. ft.
 Step Seven: Formula to calculate vent displacement
 $A = \pi r^2$ $A = \text{area} \mid r = \text{radius} \mid d = \text{depth}$
 $\pi * r * r * d = \underline{\hspace{2cm}} / 1728 = \underline{\hspace{2cm}}$

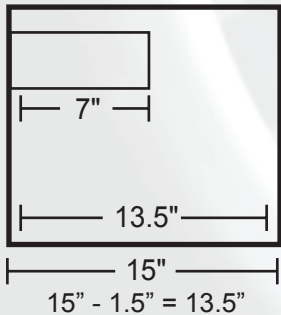

Example:
 $\pi(3.14) * r(2.25") * r(2.25") * d(7") = 111.27$ sq. in.
 $111.27 / 1728 = 0.06$ cu. ft
 $2.01 - 0.06 = 1.95$ cu. ft. enclosure

Converting a round port to a slot port.

Calculate the area of the round port(s) being used, then use the square root function of your calculator to get the interior dimensions of the equivalent square port. The length (or depth) of the slot port will be the same as that of the round port

To calculate area: (Area is a two dimensional measurement)

$$\text{Area} = \pi r^2$$

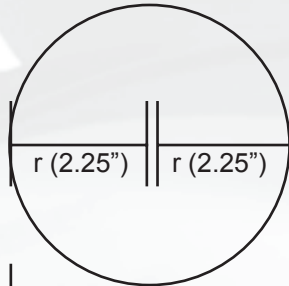
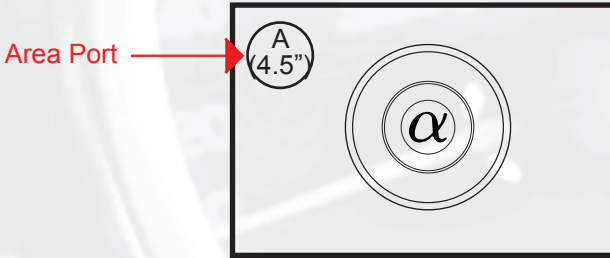

A (4.5) Port

$$\pi(3.14) * r(2.25) * r(2.25) = 15.9$$

1.5"

$$10.6 \times 1.5 = 15.9$$

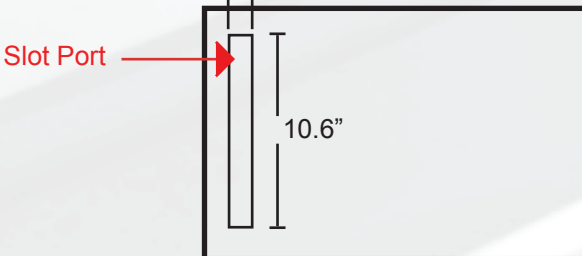

Treis Series

Model #	TSW310	TSW312		
Fs	37	31		
Qts	0.787	0.66		
Qes	0.911	0.751		
Qms	5.771	5.4		
Vas (liters)	19.61	53.63		
Vas (Cu. Ft.)	0.69	1.89		
Re	3.29	3.22		
Rms	6.192	6.708		
Xmax +/- (mm)				
Le	1.796	2.015		
Sd	339.79	518.75		
SPL	83	86.33		
EBP	40	41		
Mmd	146.15	171.51		
Freq. Resp.	35Hz-500Hz	30Hz-500Hz		

Mounting Dimensions

Depth (mm)	89mm	133mm		
Depth (Inches)	3.5"	5.3"		
Through Hole (mm)	244mm	292mm		
Through Hole (Inches)	9.6"	11.5"		
Diameter (mm)	264mm	321mm		
Diameter (Inches)	10.39"	12.6"		
Displacement	.10 Cu.Ft.	.14 Cu.Ft.		

Sealed Enclosures

Minimum Sealed	0.5	0.75		
Maximum Sealed	1.25	1.75		

Vented Enclosures

Minimum Vented	0.75	2		
Internal Volume	0.65	1.82		
Port Dia/Inches	2"	4"		
Port Length/Inches	6.5"	12"		
(-3dB)	33	33		
Tuning Freq.	40	35		
Port Displacement	0.01	0.082		

Maximum Vented	2.5	3.5		
Internal Volume	2.3	3.2		
Port Dia/Inches	4"	4"		
Port Length/Inches	6.75"	5.5"		
(-3dB)	28	29		
Tuning Freq.	35	35		
Port Displacement	0.049	0.034		

Parallel

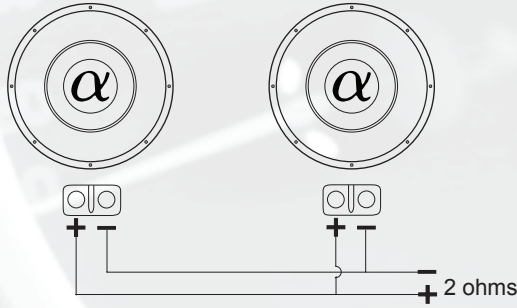
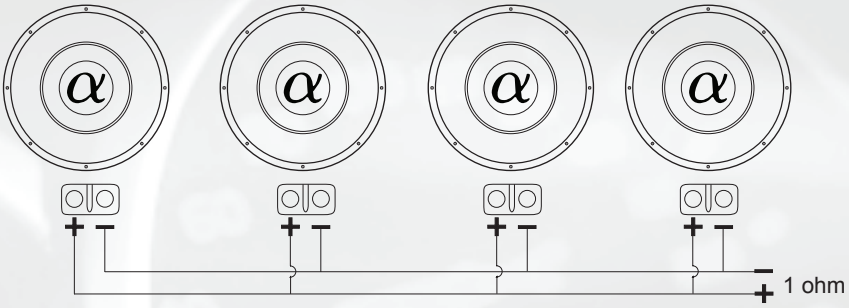

Series - Parallel

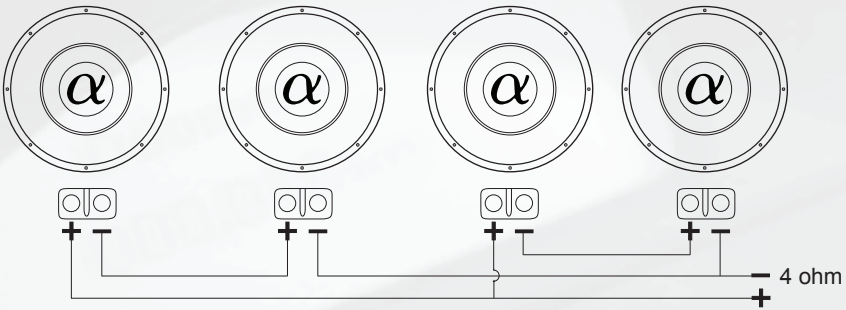

Series

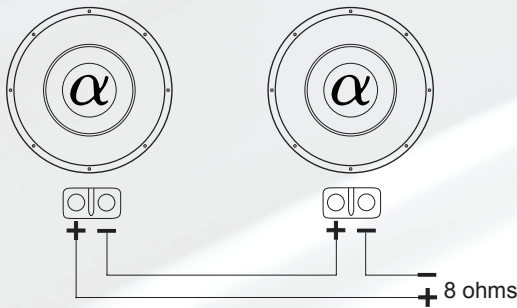

SYMPTOM	CHECK POINT	CURE
No sound	Is the amplifier power LED illuminated?	<ol style="list-style-type: none"> 1. Check fuses in amplifier 2. Check turn-on lead 3. Check signal leads 4. Check gain control 5. Check source unit volume 6. Clean contacts on fuse holders
	Is the amplifier overload LED illuminated?	Check speaker for short or amplifier for overheating
	Check impedance with Ohm meter	If no reading, replace speaker
	Check that the speaker moves freely	If speaker won't move, replace speaker
Speaker is making a rattling noise	Check that speaker is secured properly and tightened with screws	Tighten mounting screws
	Check enclosure construction	Check that the enclosure is debris free
	Check speaker polarity	Correct polarity
No sound from one coil	Check speaker leads	<ol style="list-style-type: none"> 1. Inspect for short circuits 2. Check for open connections <p>Reverse left and right speaker leads to determine if it is occurring before the speaker</p>
	Speaker is distorting at high volume levels	<p>Check speaker load impedance capabilities for the amplifier</p> <p>Verify that amplifier and/or crossover settings are correct</p>

Investigate the layout of your vehicle thoroughly before drilling or cutting. Take care when you work near the gas tank, gas lines, hydraulic lines, electrical components and electrical wiring. Do not use the equipment unmounted. Attach this system securely to prevent damage, particularly in the event of an accident or aggressive driving. Do not mount the system so that wire connections are unprotected or are subjected to pinching or damage from nearby objects. Before connecting or disconnecting power connections at the system power terminals, disconnect the +12V DC wire at the battery end. Confirm that your source unit and other equipment are turned off while connecting the input terminals. If you need to replace the power fuse, replace it only with a fuse identical to the provided fuse. Using a fuse of different type or rating may result in damage to the system, which is not covered by the manufacturer's warranty. Do not install any product where it may be subjected to excessive heat, moisture and dust or where it may be repeatedly kicked, brushed or bumped. Make absolutely sure that the terminals for the products are connected to the proper inputs and outputs from the music source. Never run the wiring on the outside of the vehicle or under it where it can be damaged by road hazards or any moving parts of the vehicle. Use existing wire channels, sills, panels and molding strips inside the vehicle to hide the wiring for safety and a neat appearance.

DISCLAIMER

IMPORTANT: Never cut any metal that is an integral part of the vehicle's safety or structural support system. If you are unsure, it is best to have the product professionally installed by an Authorized Alphasonik Dealer. Never sacrifice your safety for sound.

Alphasonik, warrants this product against all defects in material and workmanship for a period of one (1) year from the date of original purchase provided it was purchased from an Authorized Alphasonik Dealer.

The conditions of this warranty and the extent of the responsibility of Alphasonik, under this warranty are as follows:

1. DATED PROOF OF PURCHASE IS REQUIRED FOR WARRANTY SERVICE OF THIS PRODUCT. Information about Alphasonik authorized warranty service may also be obtained at www.alphasonik.com or by emailing Alphasonik at support@alphasonik.com.
2. This warranty will become void if service is performed by any one other than an approved Alphasonik Warranty Service Center.
3. This warranty does not apply to any product which has been subjected to misuse, neglect or accident, or which has had the warranty seal broken, serial number altered, defaced or removed, or which has been connected, installed adjusted or repaired other than in accordance with the instructions furnished by Alphasonik.
4. This warranty does not cover car static, electrical interference, adjustments or labor costs for the removal or reinstallation of the unit for repair.
5. The sole responsibility of Alphasonik under this warranty shall be limited to the repair or replacement thereof, at the sole discretion of Alphasonik.
6. If it becomes necessary to send the product or any defective part to Alphasonik or an authorized service station, the product must be shipped in its original or equivalent carton, fully insured, with shipping charges prepaid. Alphasonik will not assume any responsibility for any loss or damage incurred in shipping.

7. This warranty is not transferable and protects the original purchaser provided they reside and made their purchase in the United States. International consumers may contact their local retailer or distributor for warranty information.

8. ALL IMPLIED WARRANTIES, EXCEPT TO THE EXTENT PROHIBITED BY APPLICABLE LAW, SHALL HAVE NO GREATER DURATION THAN THE WARRANTY PERIOD SET FORTH ABOVE. UNDER NO CIRCUMSTANCES SHALL ALPHASONIK BE LIABLE FOR ANY LOSS OR DAMAGE, DIRECT OR CONSEQUENTIAL, ARISING OUT OF THE USE OR INABILITY TO USE THE PRODUCT. BECAUSE SOME STATES DO NOT ALLOW LIMITATIONS ON HOW LONG AN IMPLIED WARRANTY LASTS OR EXCLUSIONS OR LIMITATIONS OF INCIDENTAL OR CONSEQUENTIAL DAMAGES, THE ABOVE LIMITATIONS OR EXCLUSIONS MAY NOT APPLY TO YOU.

9. THIS WARRANTY GIVES YOU SPECIFIC LEGAL RIGHTS AND YOU MAY ALSO HAVE OTHER RIGHTS THAT VARY FROM STATE TO STATE.

10. Should you have any difficulties with the performance of this product during warranty or with any Alphasonik authorized service center, you may contact Alphasonik by emailing us at support@alphasonik.com.

PHASONIK KINOSAHPLJAALPHAS
IOSAHPLJAALPHASONIK KINOSAH
PHASONIK KINOSAHPLJAALPHAS
IOSAHPLJAALPHASONIK KINOSAH
PHASONIK KINOSAHPLJAALPHAS
IOSAHPLJAALPHASONIK KINOSAH
PHASONIK KINOSAHPLJAALPHAS
IOSAHPLJAALPHASONIK KINOSAH
PHASONIK KINOSAHPLJAALPHAS
IOSAHPLJAALPHASONIK KINOSAH
PHASONIK KINOSAHPLJAALPHAS
IOSAHPLJAALPHASONIK KINOSAH
PHASONIK KINOSAHPLJAALPHAS
IOSAHPLJAALPHASONIK KINOSAH
PHASONIK KINOSAHPLJAALPHAS
IOSAHPLJAALPHASONIK KINOSAH
PHASONIK KINOSAHPLJAALPHAS
IOSAHPLJAALPHASONIK KINOSAH



ALPHASONIK®

WWW.ALPHASONIK.COM

PROUD MEMBER OF



Copyright Alphasonik

All rights reserved. Any unauthorized reproduction or use of any Alphasonik logos, images or design elements is strictly prohibited by law. Specifications subject to change without notice.